



HP OfficeJet G Series

Your Basic Guide for Macintosh

Copyright © Hewlett-Packard Company 2000
Portions Copyright © 1989-1999 Palomar Software Inc. The OfficeJet G Series includes printer driver technology licensed from Palomar Software, Inc. www.palomar.com
Copyright © 1999-2000 Apple Computer, Inc.
Apple, the Apple logo, Mac, Mac logo, Macintosh, and Mac OS are trademarks of Apple Computer, Inc., registered in the U.S. and other countries.
All rights are reserved. No part of the document may be photocopied, reproduced, or translated to another language without the prior written consent of Hewlett-Packard Company.
Publication number: C6736-90147
First edition: June 2000
Printed in U.S.A., Germany, or Singapore

Notice

The information contained in this document is subject to change without notice and should not be construed as a commitment by the Hewlett-Packard Company.

Hewlett-Packard assumes no responsibility for any errors that may appear in this document, nor does it make expressed or implied warranty of any kind with regard to this material, including, but not limited to, the implied warranties of merchantability and fitness for a particular purpose. The Hewlett-Packard Company shall not be liable for incidental or consequential damages in connection with, or arising out of the furnishing, performance, or use of this document and the program material which it describes.

Note: Regulatory information can be found in the "Technical information" section.



It is not lawful in many places to make copies of the following items. When in doubt, check with a legal representative first.

- Governmental paper or documents:
 - Passports
 - Immigration papers
 - Selective service papers
 - Identification badges, cards, or insignias
- Governmental stamps:
 - Postage stamps
 - Food stamps
- Checks or drafts drawn on Governmental agencies
- Paper currency, traveler's checks, or money orders
- Certificates of deposit
- Copyrighted works

Safety Information



WARNING

To prevent fire or shock hazard, do not expose this product to rain or any type of moisture.

Always follow basic safety precautions when using this product to reduce risk of injury from fire or electric shock.

WARNING: Potential Shock Hazard

- 1 Read and understand all instructions in the Setup Poster.
- 2 Use only a grounded electrical outlet when connecting the unit to a power source. If you do not know whether the outlet is grounded, check with a qualified electrician.
- 3 Telephone lines can develop hazardous voltages. To avoid electrical shock, do not touch the contacts on the end of the cord, or any of the sockets on the HP OfficeJet. Replace damaged cords immediately.
- 4 Never install telephone wiring during a lightning storm.
- 5 Observe all warnings and instructions marked on the product.
- 6 Unplug this product from wall outlets and telephone jacks before cleaning.
- 7 Unplug this product from wall outlets before cleaning.
- 8 Do not install or use this product near water or when you are wet.
- 9 Install the product securely on a stable surface.
- 10 Install the product in a protected location where no one can step on or trip over the line cord, and where the line cord will not be damaged.
- 11 If the product does not operate normally, see the online Troubleshooting Help.
- 12 No operator-serviceable parts inside. Refer servicing to qualified service personnel.
- 13 Use in a well-ventilated area.

Contents

1	Additional setup information	1
	Install your HP JetDirect Print Server	1
	Connect and configure the print server	1
	Install the software	2
	Set basic fax settings using the front panel	2
	Set the date and time	2
	Set the fax header	2
	Enter text	3
	Set the answer mode	3
	Set the Rings to Answer setting	3
	Remove and reinstall your HP OfficeJet software	4
2	Review your unit's front panel	5
3	Use your HP OfficeJet with a Macintosh	7
	Review the Director	7
	Customize the Director	8
	Review the Toolbox	9
4	Get help	11
	Where can I find help?	11
	Setup Poster	11
	OnScreen Guide	11
	AppleGuide Help	11
	Internet help	12
5	Load paper or transparency film, or load originals	13
	Load the input tray with letter-, legal-, or A4-size paper	14
	Review tips for loading specific types of paper	15
	HP papers	15
	Legal-size paper	16
	Labels (only works with printing)	16
	Postcards (only works with printing)	16
	Continuous (banner) paper (only works with printing)	17
	Load the input tray with envelopes (only works with printing)	17
	Set the paper type	19
	Change the paper size for fax jobs	19
	Load originals on the glass	20
	Load originals in the automatic document feeder (ADF)	20
	Process letter- or A4-size originals exclusively	21
	Process legal- or mixed-size originals	21
	Avoid paper jams	22
6	Use the Workplace features	23
	Access the HP Workplace	23
	Create a fax cover page	24

HP OfficeJet G Series

Annotate documents	24
Create links	25
Use links	26
7 Use the print features	27
Start a print job	27
8 Use the scan features	29
Begin a scan	30
Use an HP OfficeJet that is connected directly to your Macintosh	30
Use an HP OfficeJet that is networked	32
9 Use the copy features	35
Make copies	35
Initiate the process from your HP OfficeJet	36
Initiate the process from your Macintosh	36
Stop copying	36
10 Use the fax features	37
Using AppleGuide Help	37
Enable fax confirmation	38
Send a fax	39
Initiate the process from your HP OfficeJet	39
Initiate the process from your Macintosh	40
Initiate the process from within a program	41
Receive a fax	42
Receive a fax manually	42
Save frequently used fax numbers	43
11 Support services and warranty	45
Use Hewlett-Packard's support services	45
Hewlett-Packard limited warranty	47
12 Technical information	49
Regulatory information	49
Regulatory notices	50
Declaration of Conformity	53

Additional setup information

This section provides assistance in resolving installation and configuration issues, setting fax header information using the front panel, and adding and removing software. The standard installation instructions are provided in your Setup Poster, which you should retain for later use.

Install your HP JetDirect Print Server

Your OfficeJet G Series may be networked using the HP Jet Direct 300X Print Server. For the latest information regarding networking, visit the HP Web site at:

www.hp.com/go/all-in-one

Connect and configure the print server

If you have already connected your HP OfficeJet to your Macintosh via the USB port, you must remove the USB cable and unplug the HP OfficeJet before setting up the Jet Direct Print Server.

To connect and configure the print server

- 1 Using the instructions provided with the HP JetDirect Print Server and the 1284C cable provided with the OfficeJet, set up the hardware.

NOTE Do not use the CD-ROM included in the print-server package.

- 2 Turn on the device and insert the HP OfficeJet G Series CD-ROM into your CD-ROM drive.
- 3 Locate and double-click on the **HP Network Utility** on the CD-ROM.
- 4 Select **HP DeskWriter** from the **Select a** drop-down list box.
- 5 Choose the HP OfficeJet G Series you want to install and click **OK**.
- 6 Select the Settings entry in the list on the left side.
- 7 Select **TCP/IP** in the **Please select a setting:** drop-down list box and click **Edit**.
- 8 Assign the IP number, subnet mask, and router address provided by your network administrator.

HP OfficeJet G Series

Install the software

To install the software

- 1 Double-click the **HP All-in-One Install** icon on the CD.
After the Macintosh reboots, the All-in-One Setup Wizard runs.
- 2 When asked to choose a device, select **TCP/IP** and enter the IP number of the JetDirect box in the dialog.
- 3 Complete the setup wizard.

Set basic fax settings using the front panel

You can access basic fax settings from the front panel. In the U.S., regulations require that your name and number appear on every fax. The minimum settings that we recommend are described in the following topics.

Set the date and time

Follow these steps to set the date and time manually.

- 1 On the front panel, press **Menu**.
- 2 Press **5**, and then press **1**.
- 3 After **Enter date** appears, enter the date and time using the keypad.
Use only the last two digits for the year.
- 4 After you finish entering your the date and time, press **ENTER**.
The date and time appear on the display.

Set the fax header

Follow these steps to enter your name and fax number.

- 1 On the front panel, press **Menu**.
- 2 Press **5**, and then press **2**.
- 3 Enter your name using the guidelines provided in the next section, "Enter text."
- 4 Using the keypad, enter your fax number.
- 5 After you finish entering your fax number, press **ENTER**.

Enter text

The following list provides tips for entering text using the front-panel keypad.

- Press the keypad numbers that correspond to the letters of a name.

ABC — These letters correspond to
 2 — this number, and so on.

- Press a button multiple times to see a letter first in uppercase and then in lowercase.

JKL	To get this character:	J	j	K	k	L	l	5
5	Press 5 this many times:	1	2	3	4	5	6	7

- After the correct letter appears, press ► (>), and then press the number that corresponds to the next letter in the name. Again, press multiple times until the correct letter appears.
- To insert a space, press **Space (#)**.
- To enter a symbol, such as a hyphen or parenthesis, press **Symbols (*)** to scroll through a list of symbols.
- If you make a mistake, press ◀ (<) to clear it, and then make the correct entry.
- After you are done entering text, press **ENTER** to store your entries.

Set the answer mode

To set the answer mode, choose one of the following:

- If you want your HP OfficeJet to answer every fax call automatically, verify that **Auto Answer** is enabled. (The light next to Auto Answer on the front panel is on when the feature is enabled. Press the Auto Answer button to turn it on or off.)
- If you do want to answer fax calls manually, turn **Auto Answer** off.

Set the Rings to Answer setting

This setting tells your HP OfficeJet how many rings should occur before it answers an incoming call. Follow these steps to change the Rings to Answer setting manually.

To use this feature, **Auto Answer** must be enabled. The light next to **Auto Answer** is on when the feature is enabled. Press the **Auto Answer** button to turn it on or off.

- Press **Menu**.
- Press **5**, and then press **3**.
- After **Answer on Ring** appears, press ► (>) to scroll to the desired number of rings.
- After the number you want appears, press **ENTER**.

Remove and reinstall your HP OfficeJet software

When you remove a program, you need to remove all files associated with that program, not just the files you see in a particular program folder.

NOTE Before removing your HP OfficeJet Software, make sure to save any cover pages, fax logs, and phone books that you wish to maintain.

- 1** Remove the following applications from your Macintosh:
 - Applications:HP All-in-One Software
 - Applications:Readiris
- 2** Remove the following files from your Macintosh:
 - System Folder:Extensions:DRS6 Files
 - System Folder:Extensions:HP OfficeJet Fax
 - System Folder:Extensions:HP OfficeJet Print
 - System Folder:Extensions:HP OfficeJet Scan
 - System Folder:Extensions:HP OfficeJet G55 USB
 - System Folder:Extensions:HP OfficeJet G55xi USB
 - System Folder:Extensions:HP OfficeJet G85 USB
 - System Folder:Extensions:HP OfficeJet G85xi USB
 - System Folder:Extensions:HP OfficeJet G95 USB
 - System Folder:Extensions:TWAIN Data Sources:HP Scan DS
 - System Folder:Preferences:HP All-in-One Prefs
 - System Folder:Preferences:Readiris Prefs
 - System Folder:Startup Items:HP Director Alias
- 3** To reinstall the software, see the *Setup Poster* that came with your HP OfficeJet.

Review your unit's front panel

You can perform many functions using either the front panel or the HP OfficeJet G Series software. The method you choose may depend on the function you need to perform, or it may depend on which is the most convenient.

Even if you do not connect your HP OfficeJet to a Macintosh (also called stand-alone use), you can use the front panel to process fax and copy jobs. You can change a wide variety of settings using the front-panel buttons and menu system. Depending on your model, your front panel may look slightly different from the following. Consult the legend for a brief explanation of a specific feature.

Left side of front panel

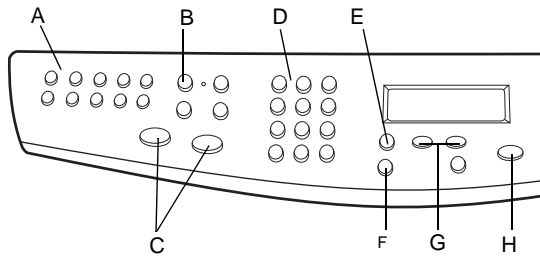

Feature	Purpose
A	Access one-touch speed-dial buttons (fax model only).
B	Turn Auto Answer on/off (fax model only).
C	Start fax (fax model only).
D	Use keypad to dial fax numbers, enter reduction/enlargement percentages, enter number of copies, or enter text.
E	Access various scan, copy, and fax settings.
F	Select or save displayed entry.
G	Scroll through scan-copy-fax-setting options.
H	Stop job, or exit menu.

HP OfficeJet G Series

Right side of front panel

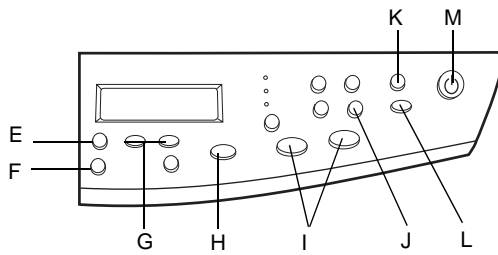

Feature	Purpose
E	Access various scan, copy, and fax settings.
F	Select or save displayed entry.
G	Scroll through scan-copy-fax-setting options.
H	Stop job, or exit menu.
I	Start copy.
J	Access special copy features, such as Fit to Page, Clone, or Poster.
K	Select a specific Macintosh or program to scan to.
L	Start scan.
M	Turn unit on/off.

3

Use your HP OfficeJet with a Macintosh

If you connect your HP OfficeJet to a Macintosh, you can work from the front panel or from the HP OfficeJet G Series software. The software offers more features and ease of use.

For comprehensive information, see the fully searchable OnScreen Guide. To access the guide, go to the Director, click Tools, and choose View OnScreen Guide.

Review the Director

Once installed, the Director automatically appears when you start-up your Macintosh. It provides centralized access to all of the capabilities of the HP All-In-One software.

The Director dynamically displays only the buttons that pertain to the attached device. You can customize the buttons that are displayed by clicking the **Customize** button. Refer to the **Customize the Director** section for additional information.

The following graphic shows some of the features available through the Director. Consult the legend for a brief explanation of a specific feature.

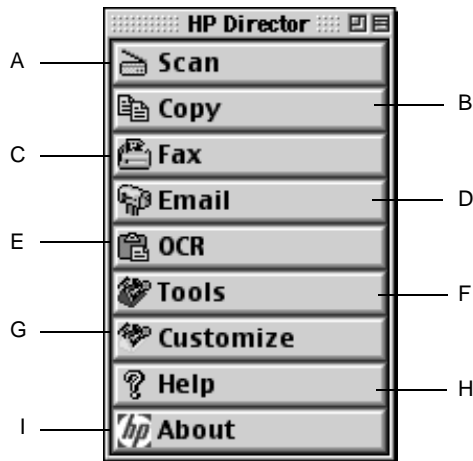

HP OfficeJet G Series

Feature	Purpose
A	Scan a document or photo and send it to a destination.
B	Copy in black and white or color.
C	Fax in black and white (only available on models with fax capability).
D	Scan a document or photo and attach it to an email message.
E	Scan a document and convert it to text for editing in a text processor.
F	Access the Toolbox.
G	Customize the appearance and functionality of the Director.
H	Access AppleGuide Help for assistance with the HP software.
I	Access copyright information about the HP software.

Customize the Director

You can customize the Director to display different functions.

To customize the Director

- 1 From the Director, click **Customize**.

The **HP Director Customization** dialog box appears with the **General** tab selected.

- 2 Click the **Button Customization** tab.

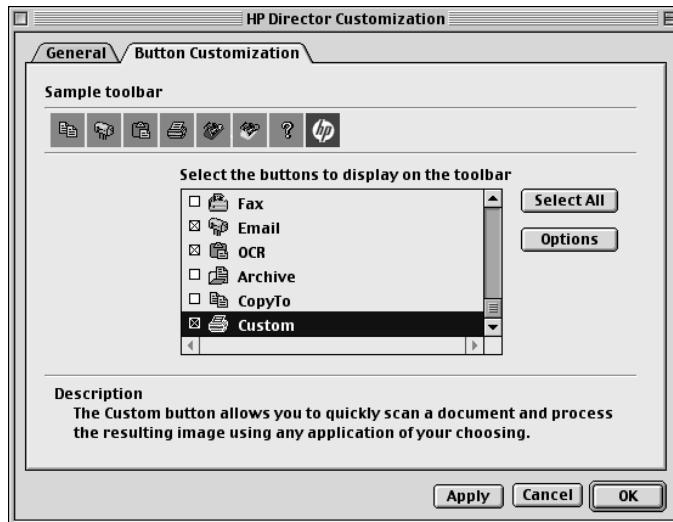

- 3 Click the buttons you want to display on the Director toolbar. If you want to display all buttons, click **Select All**.
- 4 When you have selected the buttons, click **Apply**.
- 5 Click **OK** to close the dialog box.

Review the Toolbox

The Toolbox allows you to choose and configure the HP OfficeJet device.

- ▶ To access the Toolbox, click the **Tools** button on the Director.

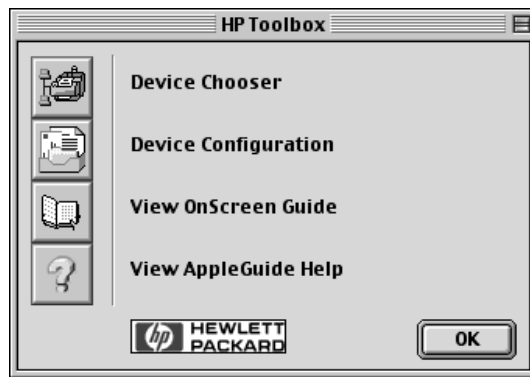

The Toolbox provides access to the following functions:

Device Chooser: Opens the Macintosh Chooser.

Device Configuration: Opens the HP All-in-One Device Settings dialog box which allows you to specify configuration options for the HP OfficeJet.

View OnScreen Guide: Displays the OnScreen Guide which provides information on how to operate and maintain your OfficeJet.

View AppleGuide Help: Displays the AppleGuide Help which provides a fully searchable help system containing information on using your HP All-in-One software for the Macintosh.

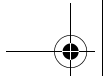

HP OfficeJet G Series

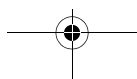
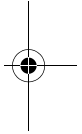
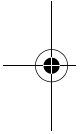

Get help

This section explains where you can find information about your unit.

Where can I find help?

For hardware and setup information:

- See the *HP OfficeJet G Series Setup Poster*. The Setup Poster is available in printed format in the box your unit came in.
- See “Additional setup information” in the *HP OfficeJet G Series: Your Basic Guide for Macintosh* and the *HP OfficeJet G Series: OnScreen Guide*. The OnScreen Guide is available by clicking **View OnScreen Guide** from the Toolbox. The Basic Guide is available in printed format in the box your unit came in.

For software information:

- See the *HP OfficeJet G Series: OnScreen Guide*.
- For more detailed information and instructions on performing everyday operating procedures using your Macintosh, refer to the AppleGuide Help files in the application. To access AppleGuide Help, go to the Director, click **Tools**, and then click **View AppleGuide Help** from the Toolbox. AppleGuide Help allows you to search for help using the index, list of topics, or by using Look For which acts like a search tool.

For feature information:

- See the *HP OfficeJet G Series: OnScreen Guide*.

Setup Poster

The Setup Poster provides installation guidelines for setting up and configuring your unit.

OnScreen Guide

The OnScreen Guide provides detailed information on using your HP OfficeJet and its features. It also provides detailed information on topics ranging from paper types to maintenance.

AppleGuide Help

AppleGuide Help provides detailed information and instructions on using your HP OfficeJet software for the Macintosh.

HP OfficeJet G Series

Internet help

If you have Internet access, you can get help from the HP Web site at:

www.hp.com/go/all-in-one

This Web site also provides user forums and answers to frequently asked questions.

5

Load paper or transparency film, or load originals

Your unit is designed to print and copy onto a variety of transparency films and paper types, weights, and sizes. It is important, however, that you choose the right paper and make sure that it is not damaged.

Your unit lets you place originals directly on the glass. With the fax model, you can also load them in the automatic document feeder (ADF).

For comprehensive information, see the fully searchable OnScreen Guide. To access the guide, go to the Director, click Tools, and choose View OnScreen Guide.

*HP OfficeJet G Series***Load the input tray with letter-, legal-, or A4-size paper**

For best results, adjust the paper settings each time you change paper types. For more information, see “Set the paper type.”

- 1 Pull out the bottom (input) tray, and slide the paper-width and -length adjusters to their outermost positions.

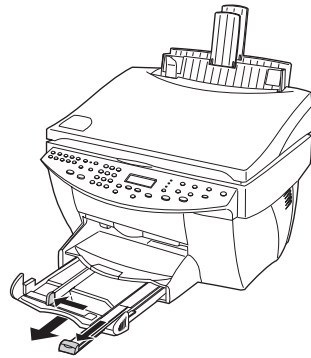

- 2 Tap the stack on a flat surface to even the edges of the paper, and then check the paper for the following:
 - Make sure it is free of rips, dust, wrinkles, and curled or bent edges.
 - Make sure all the paper in the stack is the same size and type, unless you are working with photo paper.
- 3 Insert paper into the input tray, print-side down and letterhead or top of page first, until it stops.
- 4 Slide the paper-width and -length adjusters in until they stop at the edges of the paper, and be sure that the paper stack lies flat in the input tray and fits under the tab of the paper-length adjuster.



- 5 Push the input tray back in until it stops.

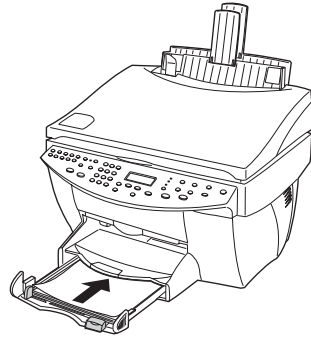

- 6 To prevent paper from possibly falling off the tray, pull out the output-tray extender.

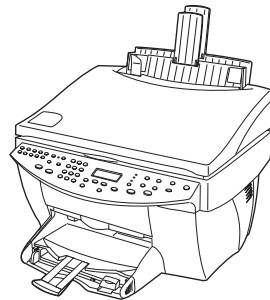

Review tips for loading specific types of paper

The following sections provide guidelines for loading certain types of paper and film. For best results, adjust the paper settings each time you change paper types. For more information, see “Set the paper type.”

HP papers

- HP Premium Inkjet Paper: Locate the gray arrow on the nonprinting side of the paper, and insert paper with the arrow side facing up.
- HP Premium Photo Paper: Load the glossy (print) side down. Always load at least five sheets in the input tray. You can place the photo-paper sheets on top of plain paper in the input tray.
- HP Premium Plus Photo Paper: Always load at least five sheets in the input tray. You can place the photo-paper sheets on top of plain paper in the input tray.
- HP Premium or Premium Rapid-Dry Inkjet Transparency Film: Insert the film so that the white transparency strip, with arrows and the HP logo, is on top and is going into the tray first.

HP OfficeJet G Series

- **HP Iron-On T-Shirt Transfers:** Flatten the transfer sheet completely before using it; do not load curled sheets. (To prevent curling, keep transfer sheets sealed in the original package until just before using.) Manually feed one sheet at a time, with the unprinted side facing down (the blue stripe faces up).
- **HP Greeting Card, Glossy Greeting Card, or Textured Greeting Card Paper:** Insert a small stack of HP Greeting Card Paper with the print-side down into the input tray until it stops.
- **HP Restickable Inkjet Stickers:** Place the sheets in the input tray, print-side (sticker-side) down.

Legal-size paper

Even though the paper-length adjuster is fully extended, make sure that the input tray itself is pushed all the way in.

Labels (only works with printing)

- Always use letter- or A4-size label sheets designed for use with HP inkjet products (like Avery Inkjet Labels), and make sure that the labels are not over two years old.
- Fan the stack of labels to make sure none of the pages is sticking together.
- Place a stack of label sheets on top of standard paper in the input tray, print-side down. Do *not* insert labels one sheet at a time.

Postcards (only works with printing)

Insert a stack of postcards with the print-side down into the input tray until it stops. Line the postcards up on the right side of the input tray, slide the width adjuster up against the left side of the cards, and slide the length adjuster in until it stops.

Continuous (banner) paper (only works with printing)

Continuous, banner paper is also known as computer or z-fold paper.

- Before loading banner paper, remove all other paper from the input tray, and then raise the output tray above the catch on the right side.

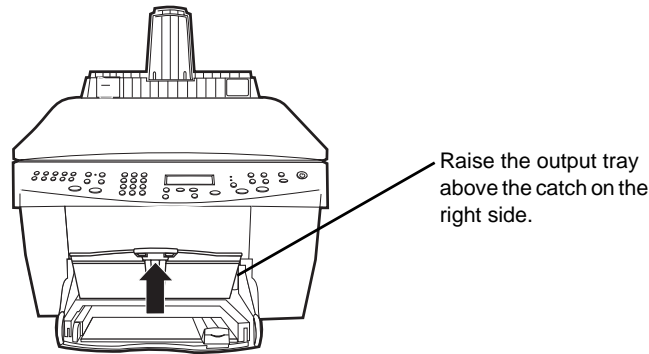

- If you use non-HP paper, use 20-lb. paper and fan the paper before loading it.
- Verify that the stack of banner paper contains at least five pages in the stack.
- Carefully tear off the perforated edge strips from both sides of the paper stack, if any, and unfold and refold the paper to make sure the pages do not stick together.
- Put the paper in the input tray so that the unattached edge is at the top of the stack. Insert the first edge into the input tray until it stops.

Load the input tray with envelopes (only works with printing)

Your HP OfficeJet provides two methods for working with envelopes. Do *not* use shiny or embossed envelopes or envelopes that have clasps or windows.

- If you are printing one envelope, use the envelope slot. Slide the envelope into the envelope slot located on the right side toward the back of the output tray, with the envelope flap up and on the left, until it stops.

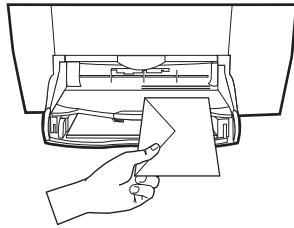

HP OfficeJet G Series

- If you are printing multiple envelopes, remove all paper from the input tray, and then slide a stack of envelopes into the tray, with the envelope flaps up and to the left (print-side down), until they stop.

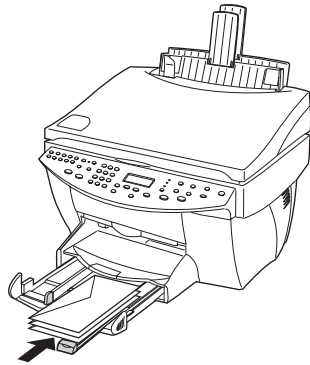

Adjust the left paper guide against the envelopes (be careful not to bend the envelopes). Make sure the envelopes fit within the tray (do not overload it).

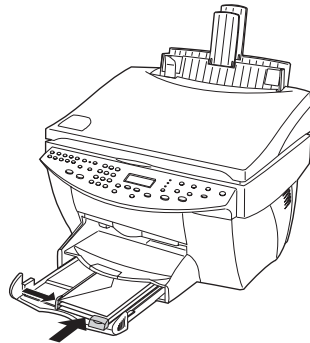

Set the paper type

After you have loaded paper or film in the unit, tell it what type of paper is loaded. Change this setting whenever you change the type of paper or film.

The paper types you specify for copying are independent of the paper types you specify for printing.

For more information, see “Recommended paper-type settings for copying” or “Recommended paper-type settings for printing” in the OnScreen Guide.

To do this for future copy jobs

Choose one of the following:

- On the front panel, press **Paper Type**. Press **▶ (>)** until the appropriate type appears. Press **ENTER** to choose the displayed paper size.
- In the Director, click **Copy**. The Copy dialog box appears. In the **Copies** area, choose the appropriate paper type from the **Type of Paper** drop-down list box, and then click **Save as Default**.

To do this for a print job

Choose one of the following:

- To do this for future print jobs, open a document. Select **Print** from the File menu and then select **Paper/Type Quality** from the drop-down list box. From the **Paper Type** list, choose the appropriate type, and then click **Save Settings**. When the dialog box appears click **OK**. Click **Cancel** to dismiss the **HP Office Jet G Series Printer** dialog box.
- To do this for the current print job, open the document that you want to print. From the File menu, choose **Print** and then select **Paper/Type Quality** from the drop-down list box. From the **Paper Type** list, choose the appropriate type, and then click **Print**.

Change the paper size for fax jobs

- 1 In the Director, click **Toolbox**.
- 2 In the Toolbox, click **Device Configuration**.
The **All-in-One Device Settings** dialog box appears with the **General** tab visible.
- 3 Click the **Fax** tab and then select **Fax Receive** from the drop-down list box.

HP OfficeJet G Series

Load originals on the glass

You can process any original by placing it on the glass.

- 1 Lift the lid, and make sure that the glass is clean.
For more information, see “Clean the glass” in the OnScreen Guide.
- 2 Place the original face down on the glass with the top edge along the green border, and align the upper-right corner of your original with the top of the white arrow and the end of the green border.

If you are copying a photo, place the *short* edge of the photo along the green border.

If you are copying from a transparency (that is, your original is printed on transparency film), place a blank piece of paper on top of the transparency.

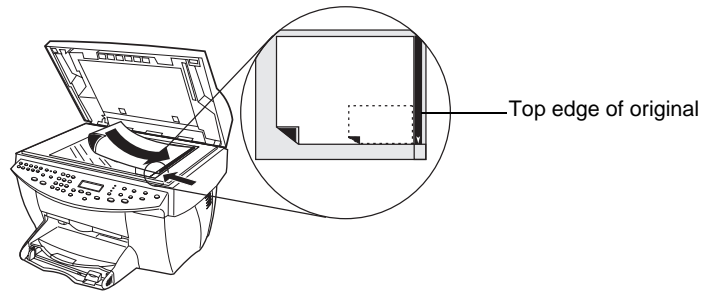

- 3 Close the lid.

Load originals in the automatic document feeder (ADF)

When using the ADF (fax model only), be aware of the following:

- To prevent paper jams, use 16-24 lb. (60-90 gsm) plain paper or HP Premium Inkjet paper only. Also, use only letter-, A4-, or legal-size originals.
- To avoid a paper jam, do not load colored originals printed on a color laser printer, photos or photo papers, transparency film, labels, envelopes, or slick-surfaced papers, such as glossy papers.
- Using the ADF, you can copy and fax *legal-size* documents, however you cannot scan them.
- You can load a maximum of 30 originals at a time when using letter- or A4-size papers.

Process letter- or A4-size originals exclusively

If you are processing *only* letter or A4-size originals, follow these steps.

- 1 Lift the lid, and make sure that the glass is clean.
For more information, see “Clean the glass” in the OnScreen Guide.
- 2 Close the lid.
- 3 Place your originals in the ADF with the printed side facing toward the back and with the top to the right (sideways).
- 4 Align the paper with the right side of the ADF.
- 5 Adjust the page guide to the length of the originals.

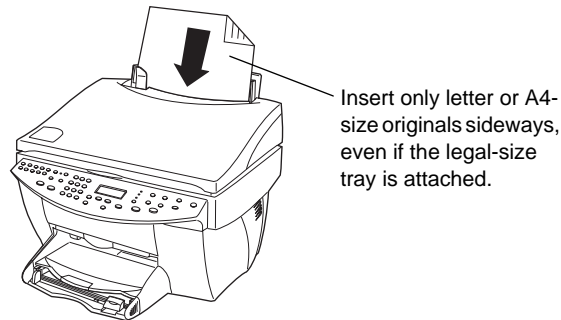

Process legal- or mixed-size originals

If you intend to copy or fax legal-size originals, follow these instructions for installing and using the legal-size tray. Legal-size paper is traditionally used only in the U.S.

To install the tray

- ▶ Slide the legal-size tray onto the *front* paper-tray extender located on the ADF lid.

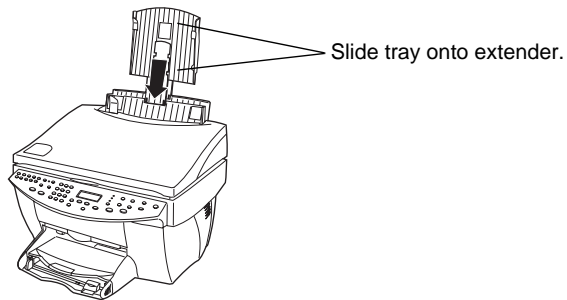

HP OfficeJet G Series

To use the ADF

- 1 Lift the lid, and make sure that the glass is clean.
For more information, see “Clean the glass” in the OnScreen Guide.
- 2 Close the lid.
- 3 Place *all* originals in the legal-size tray with the printed side facing toward the back and with the top of the document pointing down.
- 4 Align the paper with the left side of the legal-size tray.

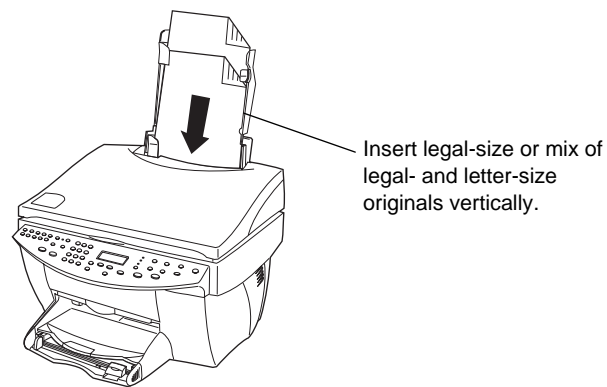

When working with originals that were originally loaded in the ADF in vertical orientation, you may notice during processing that part of the original temporarily sticks out from under the lid and a short delay occurs. This is normal behavior.

Avoid paper jams

To avoid paper jams, remove papers from the output tray frequently. Output tray capacity is affected by the type of paper and the amount of ink you are using. For more information about output-tray capacity, see “Technical information.” For help with clearing a paper jam, see the Troubleshooting Help available through the Director.

Use the Workplace features

The HP Workplace is a centralized application in which you can perform a variety of functions relating to your new HP OfficeJet. These functions include:

- Creating fax cover pages
- Annotating documents
- Creating and using links

Access the HP Workplace

You can access the HP Workplace in a number of ways:

- By clicking the **Archive** button on the Director
- By locating and clicking the **HP Workplace** icon in the **HP All-In-One** folder on the Macintosh hard drive
- By double-clicking an ODF file

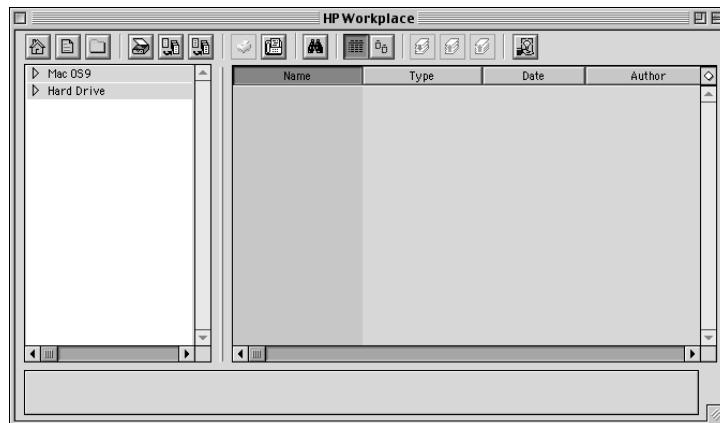

The left pane allows you to navigate through the Macintosh hard drives. The right pane displays the contents of the folder selected in the left pane of the Workplace window.

Create a fax cover page

You can use the HP Workplace to create a fax cover sheet. Once created, you can send the new cover page using the **Send Fax** application.

To create a fax cover sheet

- 1 Click the **New Cover Page** icon. Alternatively, you can select **New** and then **Cover Page** from the Workplace **File** menu.

An untitled document opens along with the HP Workplace **Tools**, **Align**, and **Properties** windows.

- 2 Create a cover page using the Workplace tools.
For more information about using the Workplace tools, refer to the AppleGuide help.
- 3 From the **File** menu, click **Save**.
- 4 Specify a filename and location and then click **Save**.

Annotate documents

You can use the HP Workplace to add annotations, such as rubber stamps and notes, to a previously scanned document.

To annotate a document

- 1 From the **File** menu, select **Import** and then **as Annotated Document**.
- 2 Browse and locate the document you want to open.
The selected document opens along with the HP Workplace **Tools**, **Align**, and **Properties** windows.
- 3 Annotate the document using the Workplace tools.
For more information about using the Workplace tools, refer to the AppleGuide help.
- 4 From the **File** menu, click **Save**.
- 5 Specify a filename and location and then click **Save**.

Create links

HP Workplace allows you to set up links that associate an application with a particular icon. Links allow scanned images to be sent to the associated application.

To create a link

- 1 From the **Edit** menu, select **Preferences**.

The Workplace **Preferences** dialog box appears with the **General** tab visible.

- 2 Click the **Links** tab.

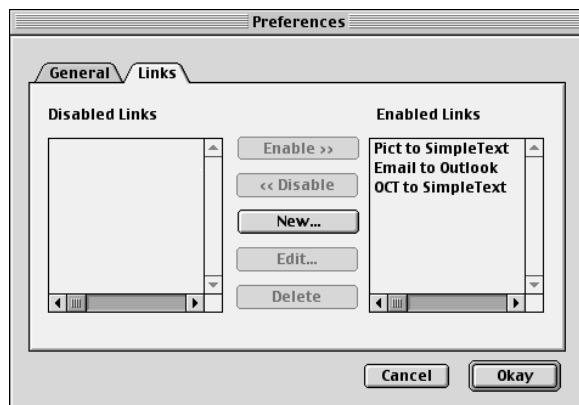

- 3 Click **New**.

The **Create Link** dialog box appears.

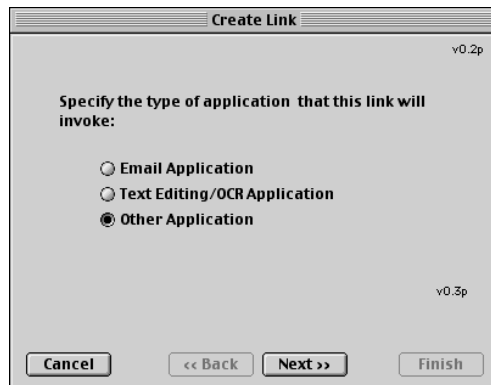

HP OfficeJet G Series

- 4 Select the type of application that the link you are creating will invoke and then click **Next**.

The Create Link dialog box displays a choice of specific applications in the category you have chosen.

- 5 From the subsections that follow, refer to the one corresponding to the type of application you are invoking:

- Email Application
- Text Editing/OCR Application
- Other Application

For more information on invoking each of these applications, refer to the OnScreen Guide.

Use links

After you create a link, the associated link icon appears on the bottom of the HP Workplace. You can then open a file in the associated application by dragging and dropping files onto the icon.

To use a link

- 1 In the file view pane of the Workplace, locate the files that you want to send to the application associated with a particular link.
- 2 Click and drag the files onto the desired icon.

The selected document opens in the associated application.

NOTE

Multi-page files are exported into multiple files of the selected type before being passed to the link.

Use the print features

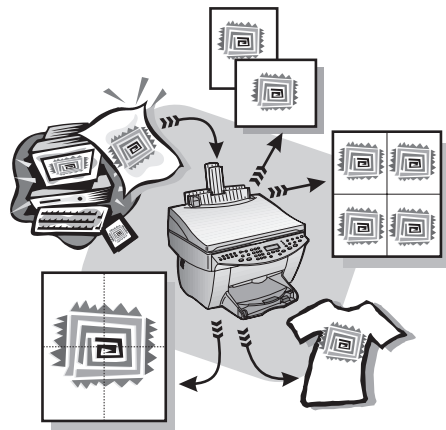

Most print settings are automatically handled by the program you are printing from or by HP's ColorSmart technology. You only need to change the settings manually when you change print quality, print on specific types of paper or film, or use special features, such as two-sided printing.

For comprehensive information, see the fully searchable OnScreen Guide. To access the guide, go to the Director, click Tools, and choose View OnScreen Guide.

Start a print job

Follow these steps to start a print job from the software program that you used to create your document.

- 1 Load the input tray with the appropriate paper.

For more information, see "Load paper or transparency film, or load originals."

HP OfficeJet G Series

- 2 From your program's **File** menu, select **Print**.
A **Print** dialog box appears on your screen.

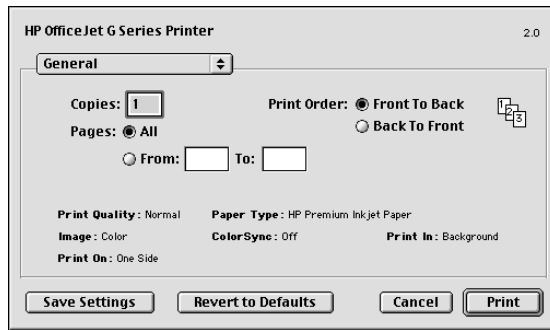

- 3 Make sure that the selected printer is **HP OfficeJet Print**.
For more information, see “Select a printer” in the OnScreen Guide.
If you need to change settings, select the appropriate setting option from the drop-down list box and set the options for your print job.
- 4 Click **Print** to begin your print job.

Use the scan features

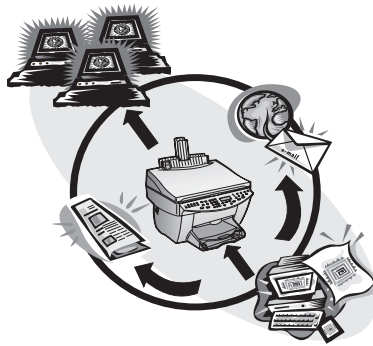

To use the scan features, your HP OfficeJet and Macintosh must be connected.

Scanning is the process of converting text and pictures into an electronic format for your Macintosh, and then using the converted items for professional and personal projects.

- Professional uses: Scan text from an article you read, and bring it into your word processor so you can quote it in your report. Include pictures of your product in your brochure. Put your logo onto business cards that you print yourself.
- Personal uses: Scan pictures of your kids, and use the images in greeting cards (or e-mail the images to their grandparents). Put a photographic inventory of your house or office on a disk, and store it in a safe place.

You can scan just about anything, such as:

- Photos - to send out or place in documents.
- Magazine articles - to store on your Macintosh.
- Text documents - to avoid retyping.
- 3D objects (be careful not to scratch the glass) - to put into catalogs and flyers.

For comprehensive information, see the fully searchable OnScreen Guide. To access the guide, go to the Director, click Tools, and choose View OnScreen Guide.

HP OfficeJet G Series

Begin a scan

You can initiate a scan from your Macintosh or from your HP OfficeJet. The steps are different depending on whether your Macintosh and HP OfficeJet are directly connected or set up through a network and depending on whether you load the original in the ADF or place it on the glass.

Use an HP OfficeJet that is connected directly to your Macintosh

You can initiate a scan from your Macintosh or from your HP OfficeJet.

To do this from your HP OfficeJet

- 1 Load your original.

For more information, see “Load originals on the glass” or “Load originals in the automatic document feeder (ADF).”

- 2 Choose one of the following:

- If you want to preview the scan, press **Scan To** repeatedly until **Scan Single Page** appears on the front-panel display, and then press **START SCAN**. Your HP OfficeJet scans the document, and then the scanned image appears in the Scan window.

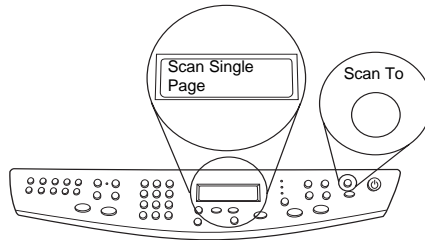

- If you want to send the scan to a specific program, press **Scan To** repeatedly until the applicable program appears on the front-panel display, and then press **START SCAN**. Your HP OfficeJet scans the document, launches the selected program, and displays the scanned image in that program.

To do this from your Macintosh

- 1 Load your original.

For more information, see “Load originals on the glass” or “Load originals in the automatic document feeder (ADF).”

- In the Director, click **Scan**.
The **Scan** dialog box appears.

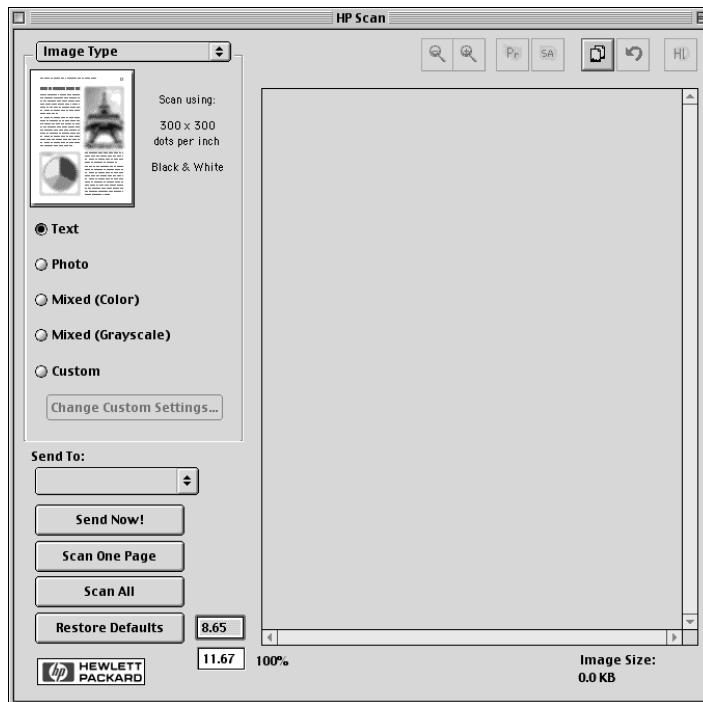

- Click the appropriate button depending on how you loaded your original document:
 - If you loaded your original in the ADF and want to scan all pages, go to the **Send To** drop-down list box and select the appropriate destination. In the **Image Type** area, select the image type, and then click **Scan All**.

Your HP OfficeJet scans the original and sends the output to the selected destination.

- If you loaded your original in the ADF and want to preview each page, select **Scan One Page**.

Your HP OfficeJet scans the document and the scanned image appears in the Scan preview window. Place your cursor in the Scan window, and then click

HP OfficeJet G Series

and drag to highlight the portion of the image to be sent to the selected destination. Click **Send Now!**

In the Scan window, click **Scan One Page** if you want to continue scanning additional pages one at a time.

- If you used the glass, your HP OfficeJet scans the document and the scanned image appears in the Scan window. Place your cursor in the Scan window, and then click and drag to highlight the portion of the image to be sent to the selected destination. Click **Send Now!**

Use an HP OfficeJet that is networked

You can initiate a scan from your HP OfficeJet or Macintosh.

To do this from your HP OfficeJet

- 1 Load your original.
For more information, see “Load originals on the glass” or “Load originals in the automatic document feeder (ADF).”
- 2 Press **Scan To** repeatedly until your Macintosh’s name appears on the front-panel display, and then press **START SCAN**.

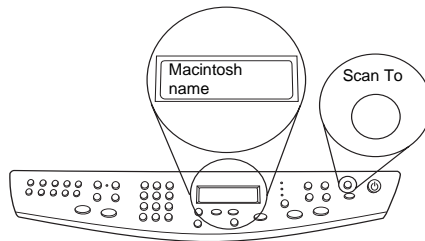

Your HP OfficeJet scans the document, and then displays it in the HP Workplace on the selected Macintosh.

To do this from your Macintosh

- 1 Load your original.
For more information, see “Load originals on the glass” or “Load originals in the automatic document feeder (ADF).”
- 2 In the Director, click **Scan**.
- 3 Click the appropriate button depending on how you loaded your original document:

- If you loaded your original in the ADF and want to scan all pages, go to the **Send To** list and select the appropriate destination. In the **Image Type** area, select the image type, and then click **Scan All**.

Your HP OfficeJet scans the original and sends the output to the selected destination.

- If you loaded your original in the ADF and want to preview each page, select **Scan One Page**.

Your HP OfficeJet scans the document and the scanned image appears in the Scan preview window. Place your cursor in the Scan preview window, and then click and drag to highlight the portion of the image to be sent to the selected destination. Click **Send Now!**

In the Scan window, click **Scan One Page** if you want to continue scanning additional pages one at a time.

- If you used the glass, your HP OfficeJet scans the document and the scanned image appears in the Scan preview window. Place your cursor in the Scan preview window, and then click and drag to highlight the portion of the image to be sent to the selected destination. Click **Send Now!**

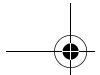

HP OfficeJet G Series

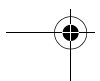
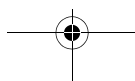
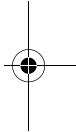
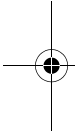

Use the copy features

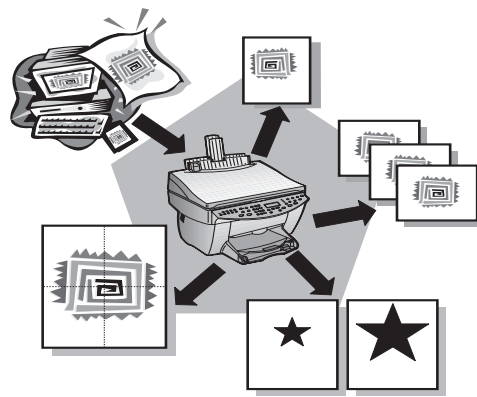

Using your HP OfficeJet, you can:

- Produce high-quality color and black-and-white copies using a variety of paper types and sizes, including iron-on transfers.
- Enlarge or reduce the size of the copies you make from 25% to 400% of the copy's original size. (Percentages may vary between models.)
- Make the copy lighter or darker, adjust the color intensity, and specify the quality of the copies you make.
- Use special digital copying features to enlarge a vacation photo (or anything else) for display on a wall, make wallet-size photos to give to family members, make high-quality copies of photos using special photo paper, or copy a report onto transparency film for use in a presentation to a client.

For comprehensive information, see the fully searchable OnScreen Guide. To access the guide, go to the Director, click Tools, and choose View OnScreen Guide.

Make copies

You can make copies using the front panel of your unit or using your Macintosh. Many copy features are available using either method. However, while you may find that the Macintosh software offers easier access to special copy features, not all functions are available.

HP OfficeJet G Series

All copy settings selected on the front panel are reset *two minutes* after the unit completes the copy job unless you save the settings as the default settings. Settings that you set in the software's Copy dialog box are reset *immediately* after you process the job. (Settings changed in the software's Copy Settings dialog box remain in effect until you change them again. For more information, see "Change settings for all future copy jobs" in the OnScreen Guide.)

Initiate the process from your HP OfficeJet

Follow these steps to start a copy job from your unit.

- 1 Load the input tray with the appropriate paper.
For more information, see "Load paper or transparency film, or load originals."
- 2 If you are using anything other than plain paper, press **Paper Type**, press ► (>) until the appropriate type appears, and then press **ENTER** to select it.
For more information, see "Recommended paper-type settings for copying" in the OnScreen Guide.
- 3 Load your original.
For more information, see "Load originals on the glass" or "Load originals in the automatic document feeder (ADF)."
- 4 If you want to make more than one copy (the default), press **Number of Copies**, and then use the keypad to enter the number of copies.
For more information, see "Set the number of copies" in the OnScreen Guide.
- 5 Change any other applicable settings, such as reduction, enlargement, or special features.
- 6 Press **Start Copy, Black** or **Color**.

Initiate the process from your Macintosh

Follow these steps to start a copy job from your Macintosh.

- 1 Load the input tray with the appropriate paper.
For more information, see "Load paper or transparency film, or load originals."
- 2 Load your original.
For more information, see "Load originals on the glass" or "Load originals in the automatic document feeder (ADF)."
- 3 In the Director, click **Copy**.
The **Copy** dialog box appears.
- 4 Change any applicable settings and click **Start Copy to start the copy job**.

Stop copying

You can stop a copy job from your unit or your Macintosh. To do so, press **Cancel** on the front panel.

Use the fax features

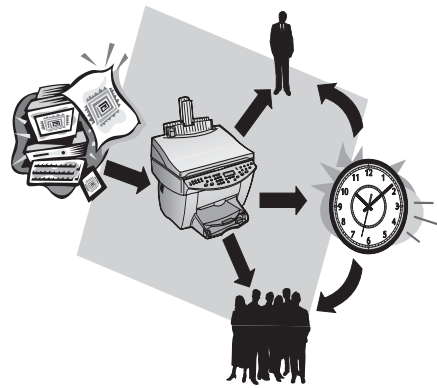

Using your HP OfficeJet (fax model only), you can:

- Send and receive paper faxes, and send faxes from your Macintosh.
- Fax documents from the automatic document feeder (ADF) or from the glass.
- Send and receive color faxes. If you send a color fax and your HP OfficeJet determines that the recipient has a black-and-white fax unit, your HP OfficeJet will interrupt the send process and resend the fax in black and white.

NOTE You can only send and receive color faxes from the HP OfficeJet device itself, not from the software on your Macintosh.

Using AppleGuide Help

For more detailed information and instructions on performing everyday operating procedures using your Macintosh, refer to the AppleGuide Help files in the application. To access AppleGuide Help, select **HP Send Fax Help** from the HP Send Fax application's Help menu. AppleGuide Help allows you to search for help using the index, list of topics, or by using Look For, which acts like a search tool.

For comprehensive information, see the fully searchable OnScreen Guide. To access the guide, go to the Director, click Tools, and choose View OnScreen Guide.

Enable fax confirmation

Your HP OfficeJet is set to print a report only if there is a problem with sending or receiving a fax. A confirmation message that indicates whether a fax was successfully sent appears briefly on the front-panel display after each fax. If you need printed confirmation that your faxes are successfully sent, follow these instructions *before* sending any faxes.

To do this using the front panel

- 1 Press **Menu**.
- 2 Press **3**, and then press **6**.
- 3 After **1. Automatic Reports Setup** appears, press **ENTER**.
- 4 Press **▶ (>)** until **Print Report Send Only** appears.
- 5 Press **ENTER** to select it.

To do this using the Macintosh

- 1 In the Director, click **Toolbox**.
The **HP Toolbox** dialog box appears.

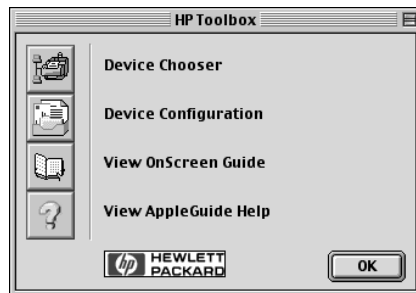

- 2 In the Toolbox, click **Device Configuration**.
The **All-in-One Device Settings** dialog box appears with the **General** tab visible.

3 Click the **Fax** tab.

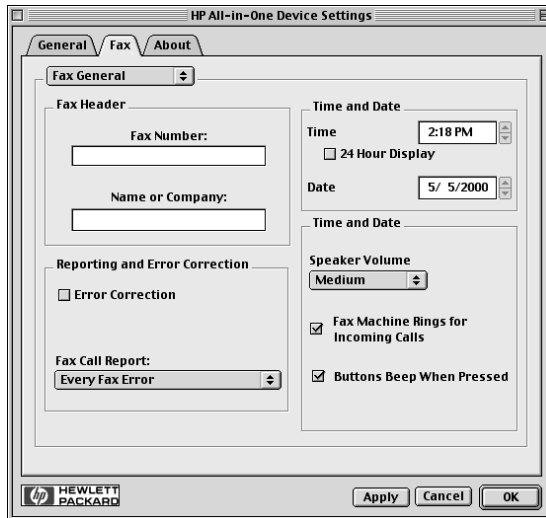

- 4** In the **Reporting and Error Correction** area, select **Send Fax Only** from the **Fax Call Report** drop-down list box.
- 5** Click **OK** to apply your changes and close the dialog box.

Send a fax

Your HP OfficeJet lets you send a fax in a variety of configurations. These include:

- Send a paper fax (using the front panel or Macintosh).
- Send a paper fax with a Macintosh-generated cover page (using the Macintosh).
- Send a Macintosh file with or without a cover page (using the Macintosh).
- Send a Macintosh-generated cover page as a single-page fax (using the Macintosh).
- Send a color paper fax (using the front panel).

Initiate the process from your HP OfficeJet

Follow these steps to use your HP OfficeJet to fax an item from the ADF or glass.

- 1** Load your original.
For more information, see “Load originals on the glass” or “Load originals in the automatic document feeder (ADF).”
- 2** To adjust the resolution, press **Resolution** to scroll through the options, and then press **ENTER**.
- 3** Enter the fax number or speed-dial code.

HP OfficeJet G Series

- To enter a regular number, dial the fax number on the keypad. Enter all the numbers you would enter if you were dialing the number from a phone.
- To use an individual or group speed-dial code, press **Speed Dial** and enter the code. If it is one of the first 10 speed dials, you can also just press the corresponding button on the one-touch pad located on the left side of the front panel.

4 Press **Start Fax, Black** or **Color**.

Initiate the process from your Macintosh

This section describes the way to initiate a fax from your Macintosh using the Director. For information on sending a fax from a specific software program, see “Initiate the process from within a program.”

1 Load your original.

For more information, see “Load originals on the glass” or “Load originals in the automatic document feeder (ADF).”

2 In the Director, click **Fax**.

The **Send Fax** dialog box appears.

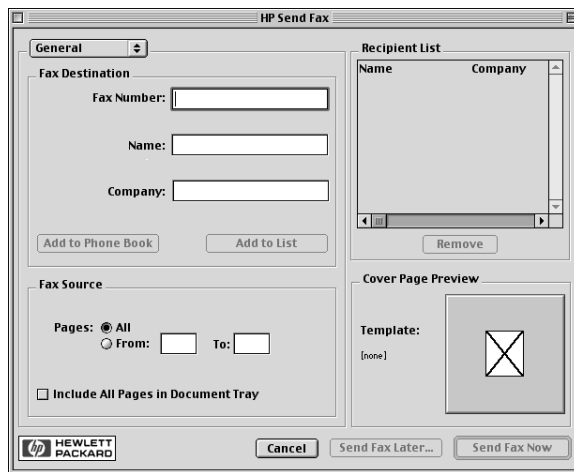

3 In the **Send Fax** dialog box, enter the fax number (or select one from the **Phone Book** or **Speed Dials lists**) and other recipient information.

For more information, see “Save frequently used fax numbers.”

4 In the **Fax Source** area, specify the pages you want to fax:

- To send all pages, click **All**.
- To send certain pages, enter the number the first page and last pages to send in the **From:** and **To:** boxes.

- 5 To include a cover page, select **Cover Page** from the drop-down list box.
- 6 Click the **Include Cover Page** checkbox and select the cover page template you want to use from the **Cover Page Template** drop-down list box.
- 7 Click **Send Fax Now**.

Initiate the process from within a program

You can fax directly from other software programs such as word processing or spreadsheet programs.

- 1 Select **Chooser** from the Apple menu.
- 2 In the Chooser, select **HP OfficeJet Fax** as the printer and then select a specific **HP OfficeJet Fax**.
- 3 Close the **Chooser**.
- 4 Open the file that you want to fax.
- 5 From your program's **File** menu, choose **Print**.

The **Send Fax** dialog box appears.

- 6 In the **Send Fax** dialog box, enter a name and fax number (or select from the address book or **Recent Faxes** list) and other recipient information.
For more information, see "Save frequently used fax numbers."
- 7 In the **Fax Source** area, specify the pages you want to fax:
 - To send all pages, click **All**.
 - To send certain pages, enter the number the first page and last pages to send in the **From:** and **To:** boxes.

- 8 To include a cover page, select **Cover Page** from the drop-down list box.
- 9 Click the **Include Cover Page** checkbox and select the cover page template you want to use from the **Cover Page Template** drop-down list box.
- 10 Click **Send Fax Now**.

HP OfficeJet G Series

Receive a fax

Depending on how you set up your HP OfficeJet, you will either receive faxes automatically or manually. For more information, see “Set the answer mode.”

Your HP OfficeJet is automatically set to print received faxes. If you receive a legal-size fax and your HP OfficeJet is not currently set to use legal-size paper, the unit automatically reduces the fax so that it fits on the paper that is loaded.

Receive a fax manually

Before manually receiving a fax to your HP OfficeJet, we recommend that you remove any originals from the ADF so that they are not accidentally processed.

To do this using the front panel

- 1 Verify that **Auto Answer** is turned *off*.
The light next to Auto Answer is off when the feature is disabled. Press the Auto Answer button to turn it on or off.
- 2 When your HP OfficeJet rings, pick up the handset of a telephone that is on the same telephone line as your HP OfficeJet.
- 3 If you hear fax tones, press **Start Fax, Black** or **Color**, or, if you are receiving from an extension phone (on the same telephone line as your HP OfficeJet, but not connected directly to it), press **1 2 3** on your phone.
- 4 After you are finished, hang up the telephone.

To do this using the Macintosh

- 1 In the Director, click **Toolbox**.
- 2 In the Toolbox, click **Device Configuration**.
The **All-in-One Device** Settings dialog box appears, with the **General** tab visible.
- 3 Click the **Fax** tab.

- 4 Select **Fax Receive** from the drop-down list box.

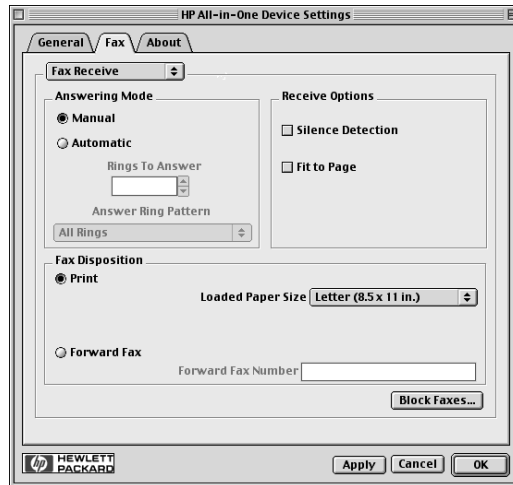

- 5 In the **Answering Mode** area, select **Manual**.
- 6 After you are finished, click **OK**.
- 7 When your HP OfficeJet rings, pick up the handset of a telephone that is on the same telephone line as your HP OfficeJet.
- 8 If you hear fax tones, press **Start Fax, Black or Color**, or, if you are receiving from an extension phone (on the same telephone line as your HP OfficeJet, but not connected directly to it), press **1 2 3** on your phone.
- 9 After you are finished, hang up the telephone.

Save frequently used fax numbers

There are two ways of storing fax numbers that you use frequently. You can assign codes that can be used in speed dialing from the front panel, and you can save numbers in the address book for use with the software.

For information about saving entries in the Fax Phone Book, refer to the AppleGuide help.

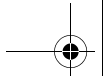

HP OfficeJet G Series

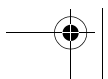
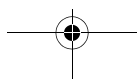
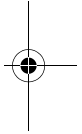
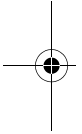

Technical information

For comprehensive information, see the fully searchable OnScreen Guide. To access the guide, go to the Director, click Tools, and choose View OnScreen Guide.

Regulatory information

The following sections describe product requirements from various regulatory agencies.

Notice to users of the U.S. telephone network: FCC requirements

This equipment complies with FCC rules, Part 68. On this equipment is a label that contains, among other information, the FCC Registration Number and Ringer Equivalent Number (REN) for this equipment. If requested, provide this information to your telephone company.

An FCC compliant telephone cord and modular plug is provided with this equipment. This equipment is designed to be connected to the telephone network or premises wiring using a compatible modular jack which is Part 68 compliant. This equipment connects to the telephone network through the following standard network interface jack: USOC RJ-11C.

The REN is useful to determine the quantity of devices you may connect to your telephone line and still have all of those devices ring when your number is called. Too many devices on one line may result in failure to ring in response to an incoming call. In most, but not all, areas the sum of the RENs of all devices should not exceed five (5). To be certain of the number of devices you may connect to your line, as determined by the REN, you should call your local telephone company to determine the maximum REN for your calling area.

If this equipment causes harm to the telephone network, your telephone company may discontinue your service temporarily. If possible, they will notify you in advance. If advance notice is not practical, you will be notified as soon as possible. You will also be advised of your right to file a complaint with the FCC. Your telephone company may make changes in its facilities, equipment, operations, or procedures that could affect the proper operation of your equipment. If they do, you will be given advance notice so you will have the opportunity to maintain uninterrupted service.

If you experience trouble with this equipment, please contact the manufacturer, or look elsewhere in this manual, for warranty or repair information. Your telephone company may ask you to disconnect this equipment from the network until the problem has been corrected or until you are sure that the equipment is not malfunctioning.

This equipment may not be used on coin service provided by the telephone company. Connection to party lines is subject to state tariffs. Contact your state's public utility commission, public service commission, or corporation commission for more information.

This equipment includes automatic dialing capability. When programming and/or making test calls to emergency numbers:

- Remain on the line and explain to the dispatcher the reason for the call.
- Perform such activities in the off-peak hours, such as early morning or late evening.

NOTICE: The FCC hearing aid compatibility rules for telephones are not applicable to this equipment.

The Telephone Consumer Protection Act of 1991 makes it unlawful for any person to use a computer or other electronic device, including fax machines, to send any message unless such message clearly contains in a margin at the top or bottom of each transmitted page or on the first page of transmission, the date and time it is sent and an identification of the business, other entity, or other individual sending the message and the telephone number of the sending machine or such business, other entity, or individual. (The telephone number provided may not be a 900 number or any other number for which charges exceed local or long-distance transmission charges.) In order to program this information into your fax machine, you should complete the steps described in the software.

*HP OfficeJet G Series***Regulatory notices**

The following sections are statements from various regulatory agencies.

FCC statement

The United States Federal Communications Commission (in 47 CFR 15.105) has specified that the following notice be brought to the attention of users of this product.

Declaration of Conformity: This equipment has been tested and found to comply with the limits for a Class B digital device, pursuant to part 15 of the FCC Rules. Operation is subject to the following two conditions: (1) this device may not cause harmful interference, and (2) this device must accept any interference received, including interference that may cause undesired operation. Class B limits are designed to provide reasonable protection against harmful interference in a residential installation. This equipment generates, uses, and can radiate radio frequency energy, and, if not installed and used in accordance with the instructions, may cause harmful interference to radio communications. However, there is not guarantee that interference will not occur in a particular installation. If this equipment does cause harmful interference to radio or television reception, which can be determined by turning the equipment off and on, the user is encouraged to try to correct the interference by one or more of the following measures:

- Reorient the receiving antenna.
- Increase the separate between the equipment and the receiver.
- Connect the equipment into an outlet on a circuit different from that to which the receiver is connected.
- Consult the dealer or an experienced radio/TV technician for help.

Product Regulations Manager, Hewlett-Packard Company, San Diego, 619-655-4100.

The user may find the following booklet prepared by the Federal Communications Commission helpful: *How to Identify and Resolve Radio-TV Interference Problems*. This booklet is available from the U.S. Government Printing Office, Washington DC, 20402. Stock No. 004-000-00345-4.

CAUTION

Pursuant to Part 15.21 of the FCC Rules, any changes or modifications to this equipment not expressly approved by the Hewlett-Packard Company, may cause harmful interference and void the FCC authorization to operate this equipment.

DOC statement (Canada)

Le present appareil numerique n'emet pas de bruits radioelectriques depassant les limites applicables aux appareils numeriques de la class B prescrites dans le Reglement sur le brouillage radioelectrique edicte par le ministere des Communications du Canada.

This digital apparatus does not exceed the Class B limits for radio noise emissions from digital apparatus set out in the Radio Interference Regulations of the Canadian Department of Communications.

Notice to users of the Canadian telephone network

The Industry Canada label identifies certified equipment. This certification means that the equipment meets certain telecommunications network protective, operational and safety requirements as prescribed in the appropriate Terminal Equipment Technical Requirements document(s). The Department does not guarantee the equipment will operate to the user's satisfaction.

Before installing this equipment, users should ensure that it is permissible to be connected to the facilities of the local telecommunications company. The equipment must also be installed using an acceptable method of connection. The customer should be aware that compliance with the above conditions may not prevent degradation of service in some situations.

Repairs to certified equipment should be coordinated by a representative designated by the supplier. Any repairs or alterations made by the user to this equipment, or equipment malfunctions, may give the telecommunications company cause to request the user to disconnect the equipment.

Users should ensure for their own protection that the electrical ground connections of the power utility, telephone lines and internal metallic water pipe system, if present, are connected together. This precaution may be particularly important in rural areas.

CAUTION

Users should not attempt to make such connections themselves, but should contact the appropriate electric inspection authority, or electrician, as appropriate.

Notice: The Ringer Equivalence Number (REN) assigned to each terminal device provides an indication of the maximum number of terminals allowed to be connected to a telephone interface. The termination on an interface may consist of any combination of devices subject only to the requirement that the sum of the Ringer Equivalence Numbers of all the devices does not exceed 5.

The REN for this product is 1.4B, based on FCC Part 68 test results.

Notice to users of the European telephone network (CTR21)

CE 0560 X

This equipment has been approved in accordance with Council Directive 98/482/EC for Pan-European single-terminal connection to the public-switched telephone network (PSTN). However, due to differences between the individual PSTNs provided in different countries, the approval does not, of itself, give an unconditional assurance of successful operation on every PSTN network termination point.

In the event of problems, you should contact your equipment supplier in the first instance.

Network compatibility Declaration of Conformity

This equipment is designed to work with telephone networks in all European Union countries plus Switzerland and Norway. Network compatibility depends on customer selected settings, which must be reset to use the equipment on a telephone network in a country other than where the product was purchased. Contact the vendor or Hewlett-Packard Company if additional product support is necessary.

This equipment comes with a telephone connector specific to the country where it was purchased.

Telecommunications general approval (UK)

Pursuant to Section 22 of Telecommunications Act of 1984, this product is approved for secondary attachment to approved primary attachment devices connected to the telecommunications network under the General Approval (NS/G/1234/5/100003).

Notice to users of the Irish telephone network

This equipment is designed for DTMF tone dialing and loop disconnect dialing. In the unlikely event of problems with loop disconnect dialing, it is recommended to use this equipment only with the DTMF tone dial setting.

Notice to users of the French telephone network

Décision ART n° xxxxF en date du xx/xx/1999

Adresse: Autorité de régulation des télécommunications, 7 square Max-Hymans, 75730 Paris Cedex 15

Internet: www.art-telecom.fr; Mél: courrier@art-telecom.fr

HP OfficeJet G Series

Notice to users of the German telephone network

The HP OfficeJet G Series products (G85, G85xi, and G95) are designed to connect only to the analogue public-switched telephone network (PSTN). Please connect the TAE N telephone connector plug, provided with the HP OfficeJet G Series, into the wall socket (TAE 6) code N. The HP OfficeJet G Series products can be used as a single device and/or in combination (in serial connection) with other approved terminal equipment.

Geräuschemission

LpA < 70 dB
am Arbeitsplatz
im Normalbetrieb
nach DIN 45635 T. 19

For non-European customers

This product is approved for use only in the country in which it was purchased. Local country laws may prohibit the use of this product outside the country of purchase. It is strictly forbidden by law in virtually every country to connect nonapproved telecommunications equipment (fax machines) to public telephone networks.

VCCI-2 (Japan)

この装置は、情報処理装置等電波障害自主規制協議会（VCCI）の基準に基づくクラスB情報技術装置です。この装置は、家庭環境で使用することを目的としていますが、この装置がラジオやテレビジョン受信機に近接して使用されると受信障害を引き起こすことがあります。
取り扱い説明書に従って正しい取り扱いをして下さい。

Notice to users of the Korean telephone network

사용자 안내문 (A급 기기)

이 기기는 업무용으로 전자파규격검정을 받은 기기이오니, 주의 권고 구입하십시오. 판매-구입한 곳에서 비업무용으로 교환이시게 바랍니다.

사용자 안내문 (B급 기기)

이 기기는 비업무용으로 전자파규격검정을 받은 기기로서, 주거지역에서는 물론 모든 지역에서 사용될 수 없습니다.

Notice to users of the New Zealand telephone network

- 1 This equipment shall not be set to make automatic calls to the Telecom '111' Emergency Service.
- 2 This equipment should not be used under any circumstances which may constitute a nuisance to other Telecom customers.
- 3 A Telepermit for any terminal equipment indicates only that Telecom accepts that the item complies with minimum conditions for connection to its network. It indicates no endorsement of the product by Telecom, nor does it provide any sort of warranty. Above all, it does not assure that any item will work correctly with another item of Telepermitted equipment of a different make or model, nor does it imply that any product is compatible with all of Telecom's network services.
- 4 The decadic (or pulse) dialing on this device is unsuitable for use on the telecom network in New Zealand.
- 5 Not all telephones will respond to incoming ringing when connected to the extension socket.
- 6 When using the remote fax-receive feature by pressing 1-2-3, the tones generated by the telephones must be at least 65 milliseconds in duration or greater.

Declaration of Conformity

According to ISO/IEC Guide 22 and EN 45014

Manufacturer's Name and Address:

Hewlett-Packard Company, 16399 West Bernardo Drive, San Diego, CA 92127-1899, USA

declares that the product

Product Name: OfficeJet G55, G55xi, G85, G85xi, G95
Model Number(s): C67xxA, where x=34, 35, 36, 37, 38, 39, and 40
Product Options: None
Note: See Declaration of Similarity for product descriptions.

conforms to the following Product Specifications:

Safety: EN60950:1992 +A1, A2, A3, A4, and A11
IEC60950: 1991 +A1, A2, A3, and A4
UL1950, 3rd Edn: 1995
CSA22.2 No. 950 3rd Edn: 1995
NOM-019-SCFI-1993
IEC 825-1:1993 / EN 60825-1:1994 +A11 Class 1

EMC:

CISPR22:1993, +A1 and A2 / EN 55022:1994, +A1 and A2 - Class B*
EN50082-1:1997
IEC 61000-4-2:1995 – 4kV CD, 8kV AD
IEC 61000-4-3:1995 – 3V/m
IEC 61000-4-4:1995 – 1kV Pwr Line
IEC 61000-4-5:1995
IEC 61000-4-6:1996
IEC 61000-4-8:1993
IEC 61000-4-11:1994
IEC 1000-3-2:1995 / EN61000-3-2:1995
IEC 1000-3-3:1994 / EN61000-3-3:1995

AS / NZS 3548:1992
Taiwan CNS13438
FCC Part 15 – Class B / ICES-003, Issue 2 / VCCI-2

Supplementary Information:

The Product herewith complies with the requirements of the Low Voltage Directive 73/23/EEC and EMC Directive 89/336/EEC, and carries the CE marking accordingly.

European Contact: Your local Hewlett-Packard Sales and Service Office or Hewlett-Packard GmbH.
Department HQ-TRE, Herrenberger Strasse 130, D-71034 Böblingen (FAX + 49-7031-14-3143)

* The product was tested in a typical configuration with Hewlett-Packard Vectra Personal Computer Systems

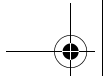

HP OfficeJet G Series

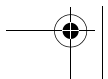
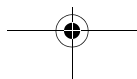
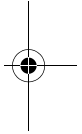
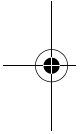

Index

A

- A4-size original, load in ADF 21
- add programs 4
- address book 43
- ADF, using 22
- answer mode, setting 3
- AppleGuide Help 11
- automatic document feeder (ADF)
 - install legal-size tray 21
 - place original in 20

B

- banner paper, tips on loading 17
- buttons, front-panel description 5

C

- copy
 - from ADF 20
 - from front panel 36
 - from glass 20
 - initiate from Macintosh 36
 - introduction 35
- customer support 45
- customize Director 8

D

- Director
 - customize 8
 - fax from 40
 - introduction 7
 - scan from 30, 32
- document files, fax 41

E

- envelopes, tips on loading 17

F

- fax
 - assign speed-dial codes 43
 - basic settings 2
 - confirm send 38
 - enter text 3
 - from ADF 20
 - from front panel 39
 - from glass 20
 - from Macintosh 40
 - from within a program 41
 - introduction 37
 - receive manually 42
 - rings to answer 3

- save numbers 43
- send 39
- set the header 2
- set time and date 2
- front panel 5
 - button descriptions 5
 - copy from 36
 - fax from 39
 - scan from 30, 32

G

- glass, place original on 20

H

- hardware, help 11
- help, access 11
- HP Customer Support 45
- HP Distribution Center 46
- HP papers, tips on loading 15

I

- initiate
 - copy from front panel 36
 - copy from Macintosh 36
 - fax from front panel 39
 - fax from Macintosh 40
 - print 27
 - scan from front panel 30, 32
 - scan from Macintosh 30, 32
- input tray, load paper 14
- Internet help 12
- internet support 45
- introduction
 - copy 35
 - Director 7
 - fax 37
 - print 27
 - scan 29
 - software 7

L

- labels, tips on loading 16
- legal-size original, load in ADF 21
- legal-size paper, tips on loading 16
- legal-size tray installation 21
- letter-size original, load in ADF 21
- links, using 26
- load
 - original in ADF 20
 - original on glass 20

*HP OfficeJet G Series***M**

Macintosh

- copy from 36
- fax from 40
- scan from 30, 32

N

- network, scan from networked unit 32

O

OnScreen Guide overview 11

overview

- copy 35
- fax 37
- print 27
- scan 29

P

paper

- avoid jam 22
- load 14

paper type, set 19

phone numbers, support services 45

postcards, tips on loading 16

power specifications 49

print

- continuous (banner) paper, tips on loading 17
- envelopes, tips on loading 17
- introduction 27
- postcards, tips on loading 16
- start 27

programs

- add and remove 4
- fax from within 41
- print from within 27

R

receive a fax 42

regulatory information 49

remove programs 4

review the toolbox 9

Rings to Answer setting 3

S

save fax numbers 43

scan

- from ADF 20
- from Director 30, 32
- from front panel 30, 32
- from glass 20
- from Macintosh 30, 32
- from networked unit 32
- from unit directly connected to Macintosh 30
- introduction 29

start 30

send

- fax 39
- fax from Macintosh 40

setting answer mode 3

settings

- basic fax 2
- fax header 2
- Rings to Answer 3
- time and date 2

setup

- additional information 1
- help 11

Setup Poster 11

software

- add and remove 4
- fax from 40
- help 11
- introduction 7
- scan from 30, 32

specifications 49

specifications, power 49

speed dialing 43

start

- copy from front panel 36
- copy from Macintosh 36
- fax from front panel 39
- fax from Macintosh 40
- print 27
- scan 30
- scan from front panel 30, 32
- scan from Macintosh 30, 32
- support services 45

T

technical specifications 49

telephone numbers 45

text, enter on front panel 3

toolbox, review 9

tray

- empty output 22
- install legal-size tray 21
- load input 14

U

using

- ADF 22
- links 26

W

warranty 45, 47

Web, HP site 12

HP OfficeJet Menu

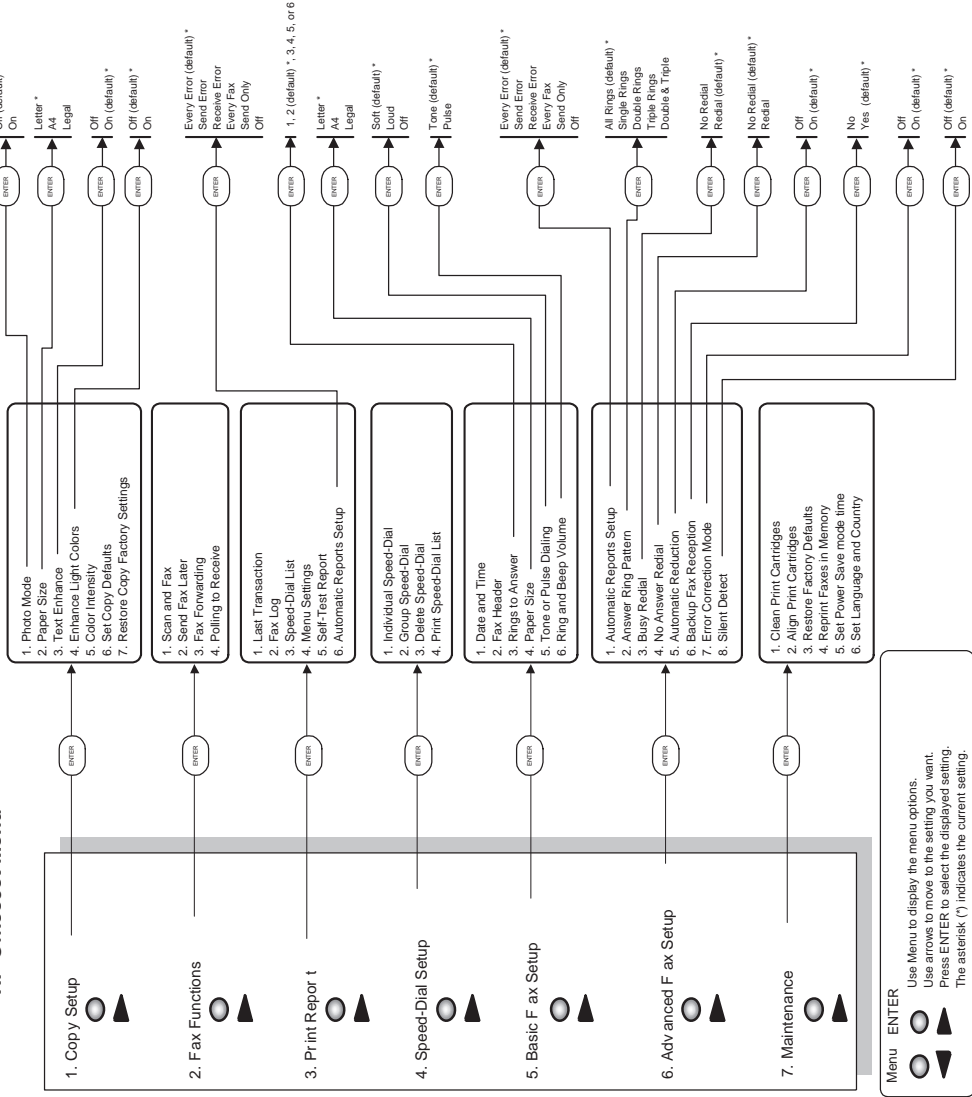

Visit the HP All-in-One Information Center.

It's everything you need to get the most value from your HP OfficeJet.

- Technical Support
- Supplies and Ordering Information
 - Project Tips
- Ways to Enhance Your Product

www.hp.com/go/all-in-one

© 2000 Hewlett-Packard Company

Printed in the U.S.A., Germany, or Singapore.



C6736-90147